

Article number: 2012421220

Description: E+G
Pin with axial lock GN 124.2-12-20

Measures

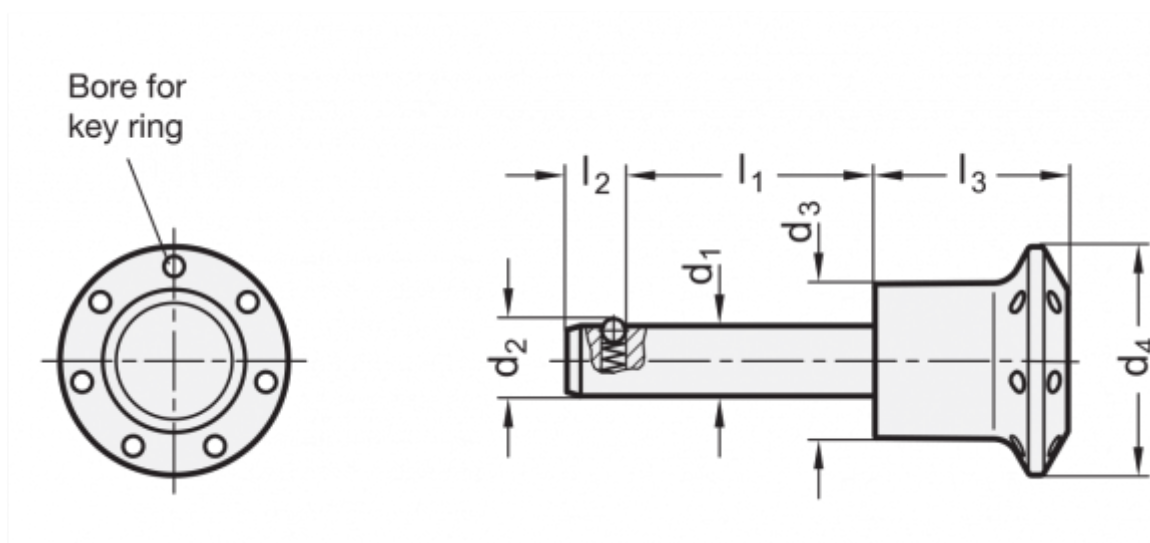

Axial grasping power on pins N = 32	= 32	$l_2 = 9.5$
Bore for pin D12	= 12	$l_3 = 27.0$
d1	= 12	
d2	= 14.5	
d3	= 18.5	
d4	= 31	
Dividing power (double) in kN	= 30	
l1	= 20	